

ELECTRICAL- AND SUN-POWERED GLIDERS: DO THEY REQUIRE A DEFINITION OF NEW F.A.I. CLASSES?

by Pierluigi Duranti, F.A.I., Fédération Aéronautique Internationale

Presented at the XXV OSTIV Congress, St. Auban, France

1. Summary

Recent interesting achievements in the field of solar-powered flight have demonstrated that the technology is available for aircraft capable of safely taking-off and reaching a soaring altitude in complete autonomy. In addition solar energy could also be used to power on-board devices capable of indirectly improving the aerodynamic performance of a flying machine, for instance a boundary layer suction system, such as that recently studied by Prof. Boermans of Delft University.

The cost of solar cells, hardly affordable for a long time, is now reducing and the efficiency of panels is progressively improving. These developments are encouraging several initiatives in the world, aimed at developing sun-powered aircraft.

Much less expensive than "sun-powered" aircraft and technically more affordable are "pure electrical-powered" motorgliders. It has been demonstrated by some successful examples in the world that a "conventional" light motorglider can climb up to an altitude comparable to that of a standard aero tow, at a safe climbing rate, by means of a proper set of batteries. In fact battery tech-

nologies, as well, have shown significant improvements, both in terms of power/weight and energy/weight ratios.

All of this has drawn the attention of the aeronautical world to electrical- and solar-powered flight.

The F.A.I., in this respect, recently established a dedicated working group, which the author belongs to. Its aim shall be that of monitoring the development of these new aircraft and studying the requirements of possible new F.A.I. classes for world record breaking and competitions.

This paper presents a short history of these pioneering experiences, points out the technical differences between the few existing (flying) examples and mentions some predictable improvements as well as other alternative energy accumulation/management means of the near future.

Far from anticipating answers, this paper addresses a series of questions to be answered and develops some considerations about these new airplanes, mainly related to their classification and to the relationships between such possible new categories and those already existing.

2. Introduction

The recent competition dedicated to sun-powered aircraft, the "Berblinger prize '96," held in Germany by the initiative of the city of Ulm, has produced a certain impulse towards the development of efficient light aircraft capable of safely taking-off and maintaining level flight in complete autonomy. An important requirement, amongst others, was that of carrying on board "standard" pilots, i.e. heavier than a jockey. The aircraft winner, the German "Icare," demonstrates that the relevant technologies are now mature for opening the path to possible practical applications of solar panels for flight.

Significant advances have been made in solar cells over the last few years, and solar arrays are expected to become significantly different from the silicon arrays that have been dominant so far. Solar cells with efficiency over 20% (Reference 1) will be available soon. In addition, thin film arrays are being developed that could be, contrary to the past, extremely radiation tolerant, low cost, light weight and more efficient, although less efficient than solid solar panels. Still a large spread of costs will differentiate the cells of the highest quality from the others. This aspect shall have to be carefully considered when establishing new classes of aircraft and rules for competitions.

More technically and economically affordable aircraft than solar-powered are "pure electrical-powered" gliders. Notwithstanding some progress in the area of electrical storage systems, today a continuous employment of batteries on an aircraft is not effective and practical. For the time being, therefore, it appears that a "conventional" electrical power plant is a promising and suitable application for self-launching gliders, which require power just for the take-off climbing phase before starting soaring flight. Examples exist in the world of light gliders capable of taking-off and climbing at soaring altitude using the energy stored in packages of batteries. Their weight is not excessive any longer and the perfor-

mance obtainable in terms of gliding characteristics are quite interesting both for training/recreation purposes and for competition flight (Reference 2).

In addition to advanced types of electrical batteries there are on the horizon, other interesting means of energy storage, which promise to become suitable for powering electrical motors in the future. Some of these concepts are already widely adopted on spacecraft, such as flywheels, supercapacitors and, above all, regenerative fuel cells based on water cycle. The energy storage efficiency of a regenerative fuel cell is lower than most rechargeable batteries but its energy density is about ten times, more than twice the energy density of advanced zinc-air batteries. Although today's high cost of such devices makes their adoption unaffordable outside government industries research environments, a reduction in terms of cost is expected soon, which will make their adoption on aircraft more affordable (Reference 3).

For the aforementioned reasons, therefore, it is not unlikely that, within a few years, a scene like that painted in the picture (Figure 1) may become a reality. The ecological issue is also interesting, particularly in those countries where severe restrictions to sporting flight are applied because of acoustic pollution.

The aforementioned leads directly to the question: "how can these new types of flying machines be classified and properly grouped in a suitable way for promoting the designer's efforts in a competitive environment and for allowing fair competitions?" This is not an easy question to be answered. Whilst it is necessary to rapidly be ready for "certifying" the world records which the few flying machines have (unofficially but actually) broken so far, on the other hand it is still uncertain how quickly and steadily the actual trend of this movement will progress. In fact this will be tightly related to the technical development that the relevant technologies will demonstrate in the near future. Since the technology of solar panels and that of electrical accumulation are areas subject to very rapid evolution, any definition attempt must be very cautious and should not prevent subsequent readjustments and refinements made necessary by their technological evolution. This is difficult to be exactly predicted today.

3. Historical background

During more than two hundred years of human flight and almost hundred years of airplane flying the examples of electrical propulsion have been very few. It is therefore quite rapid an exercise that of going along the main milestones in this short history (References 4,5):

1881: During the international exposition in Paris the brothers Tissandier presented a small airship model, electrically powered, which flew in the display building.

Subsequently (1883) they developed an actual size airship (1600 m³), 28 m. long, but the limited electrical power delivered by the dynamo used as a motor was not sufficient to guarantee the control of the airship.

1884: Maybe not everybody knows that the first mobile

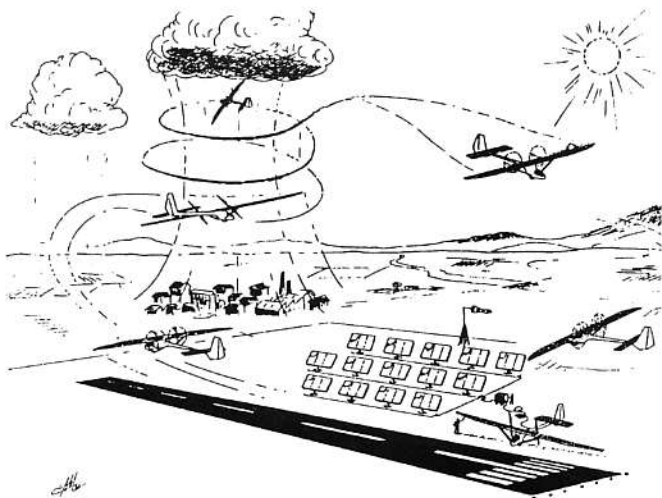

Figure 1. A possible scene for the 21st Century.

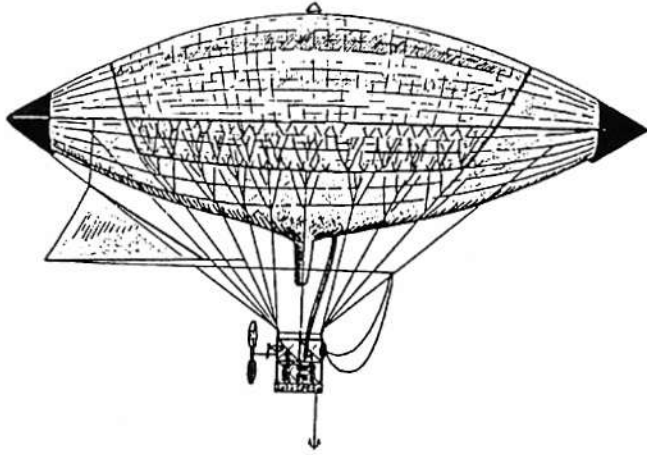

Figure 2. 1883, first flight trial of an airship (electrically powered) by Tissandier brothers.

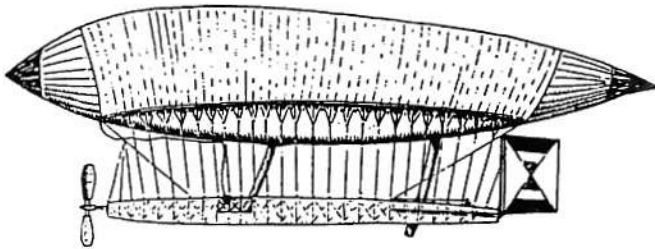

Figure 3. 1884, Airship "La France", first flying machine in the world to successfully navigate (it was electrically powered.)

air vehicle in the history actually operated by a pilot, the French airship "La France," was pushed by an electrical engine. Built and flown by the colonels Charles Renard and Artur C. Krebs, it gave the first demonstration of flight navigation. However, since those early days, it was quite clear that the generally unfavorable weight/power ratio of electrical accumulators would have prevented the diffusion of that kind of propulsion system in aeronautics for long time.

1953: The photovoltaic effect, demonstrated by the physician Becquerel in 1839, was practically applied for the first time when the silicium solar cells were developed at Bell Laboratories.

1954: The aerodynamicist Prof. Rasper put forward the idea of a solar-powered aircraft, but the initially limited efficiency of solar cells, high cost, fragility and weight prevented from practical in flight applications.

1960/1970: Fred Militky and other aero-modelers in the world developed electrical solar powered free-flight and radio controlled models.

1973: In that year it was possible to observe in flight the first manned heavier-than-air aircraft electrically powered, when the Czechs Heino Brditschka and Fred Militky realized and flew, in Austria, the electrical version of a

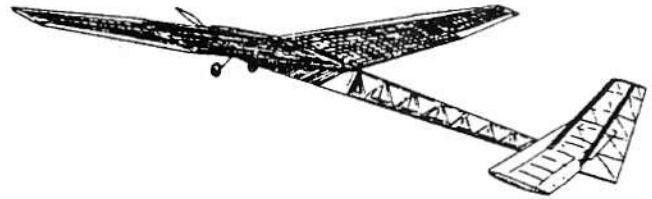

Figure 4. 1974, "Sunrise", first solar-powered aircraft (unmanned).

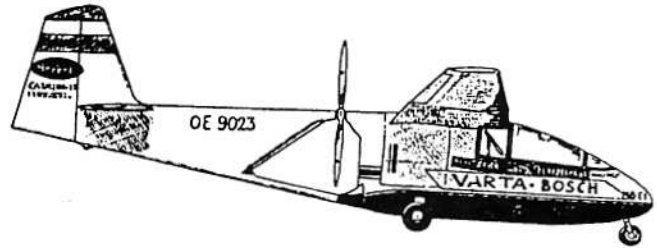

Figure 5. 1973, "MB-E1", first electrically-powered glider.

conventional motor-glider, the Raab "Crab" HB-3. It was named MB-E1 and was powered by a 13 Hp Bosch electrical motor. A few take-off demonstrations, with climb up to 300 m, were experienced, but that remained an episodic event without any further development for long time (Reference 6).

1974: The characteristics of solar cells had significantly improved and costs reduced, mainly because of the push produced by the aerospace environment. The specific power density became comparable with that attained by the best electrical batteries available at that time. It became therefore feasible to consider solar power for flight. This allowed Bob Boucher to build and fly the world's first solar powered RPV (Remotely Piloted Vehicle), the Sunrise 1, followed in 1975 by Sunrise 11, which set an altitude record at 17,200 ft. (Reference 7).

1978: In England Frederick Ernest To and David Williams designed and flew the Solar One, a motorglider type aircraft, initially developed for muscular flight, subsequently powered by an electric motor. It was driven by batteries charged before flight by a solar cells array on the wing (sun-power available was just a small fraction of what necessary for level flight) (Reference 8).

1979: In California Larry Mauro, of Ultralight Flying Machines, developed the Solar Riser, a solar-powered version of the biplane hang glider Easy Rider. Also in this case the wing surface covered by solar panels was not sufficient for guaranteeing sustained flight. However that airplane, for its innovative approach, deserved an

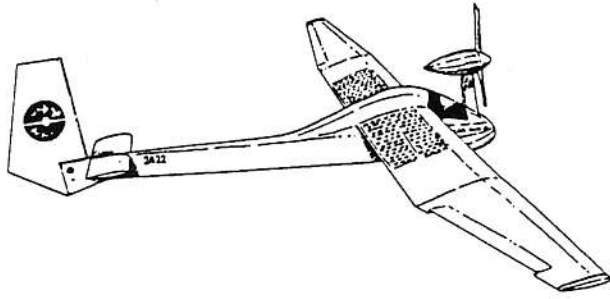

Figure 6. 1978, "Solar One", (England) solar-powered aircraft (partially sustained).

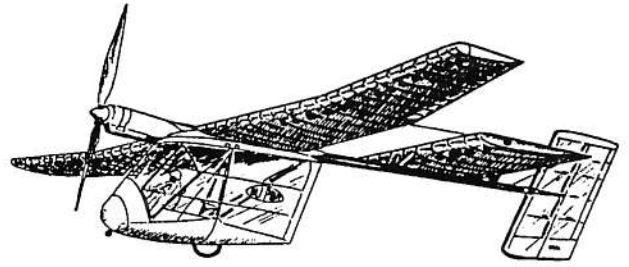

Figure 9. 1980, "Solar Challenger", first solar-powered aircraft to cross the Channel.

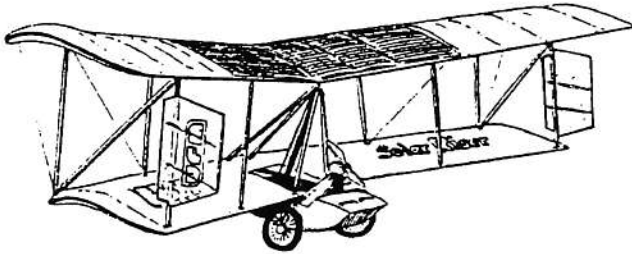

Figure 7. 1979, "Solar Riser" (USA) solar-powered hang glider (partially sustained).

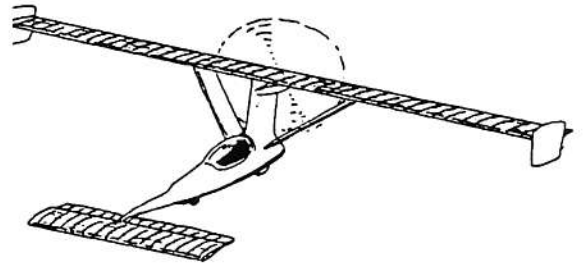

Figure 10. 1980, "Solair 1", first solar-powered aircraft in Europe.

honor place in the Oshkosh museum (Reference 9).

1980: The Gossamer Penguin, built by Paul MacCready, was the first aircraft to actually demonstrate the total capability of sun (only)-powered sustained flight, although in ground effect only. Initially developed for muscular flight as back up of the Gossamer Albatross, the Penguin was converted to solar power by installing the Sunrise's solar panels. MacCready's 13 year-old son Marshall (40-Kg weight) piloted the first flight (30-sec. at 1.5-meter height). That aircraft, being a derivative, had many shortcomings. The added payload of solar cells made control difficult, there was insufficient power to take-off without a bicycle tow, and structurally the airframe was barely

capable of supporting its own weight during flight, limiting it to a safe height of about 10 ft. Nevertheless it served its purpose as a development prototype, providing essential information and experience that insured success for the subsequent Solar Challenger. (Reference 10).

1980/1981: The first aircraft developed expressly for solar flight, capable of actually flying also in turbulent atmosphere, was the Solar Challenger, another design of Paul MacCready and his group. It represents a milestone in the history of solar-powered flight and is still the only aircraft in the world capable of taking-off and climbing using solar-power only. Its main achievements consisted

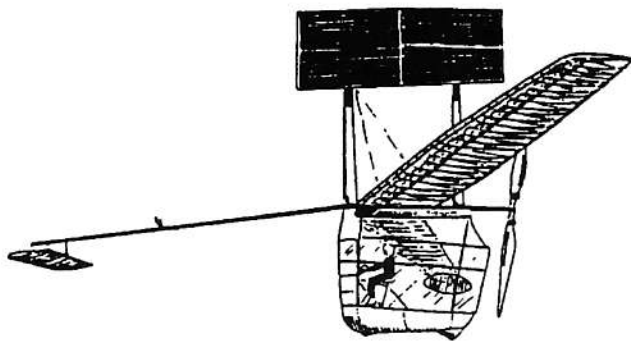

Figure 8. 1980, "Gossamer Penguin" (USA), first solar-powered aircraft to maintain level flight (in ground effect).

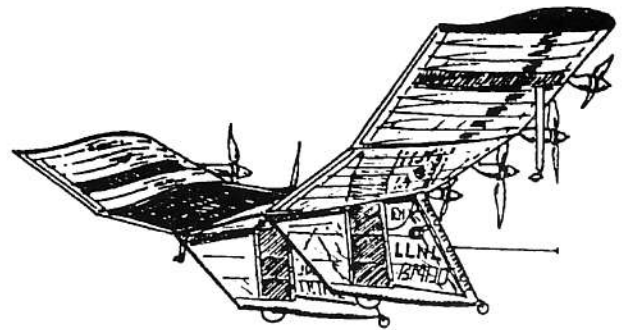

Figure 11. "Pathfinder", high altitude sun-powered planform flying demonstrator.

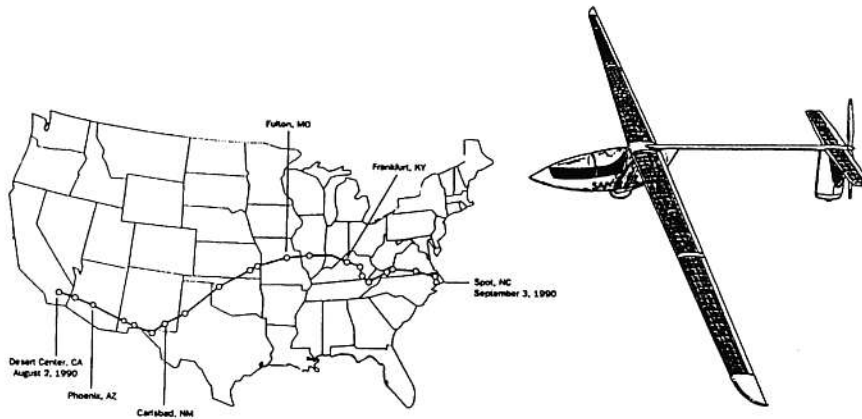

Figure 12. "Sunseeker" (USA) solar-(partially) powered glider, in 1990 crossed the States from coast to coast in 23 days, leg by leg.

of the Channel crossing and an 8 hours duration flight up to 4000 meters maximum height (Reference 11).

1980: The first solar-powered aircraft in Europe was the Solair 1, designed and built by the Germans E. Schoeberl and G. Rochelt as a derived version of the Swiss canard glider "Canard SC" (Reference 12).

1983/1997: In the years eighty NASA had undertaken projects aimed at studying the feasibility of High Altitude Sun-Powered Planform, both for meteorological and military surveillance purposes. Some of those unmanned aircraft were expected to take advantage of solar power for staying aloft practically continuously once provided with suitable energy-storage system capable to power motors during the night.

Pathfinder, recently developed, again under the heading of Paul MacCready, is a solar-powered flying wing high altitude planform demonstrator, 100 feet wing span, pushed by eight electrical motors, with many innovative technical peculiarities as far as control system is concerned (Reference 13).

1986/1990: Another interesting aircraft worth to be mentioned is the Sunseeker of Eric Raymond, a solar assisted proof of concept prototype, with extraordinary characteristics and design choices. Also in this case, as for some other solar-powered machines previously described, the efficiency/area of the installed solar panels did not pro-

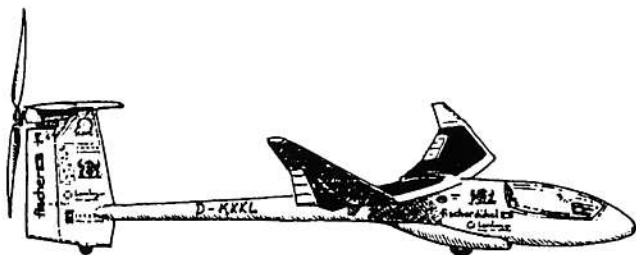

Figure 13. "Icarè" (Germany), solar-powered aircraft winner of the Berblinger Prize, 1996.

vide sufficient power for sustained flight. However an optimized combination of low weight, high aerodynamic efficiency and balanced design of the electro-solar power plant allowed Eric Raymond to demonstrate excellent performance and an innovative approach as far as possible development of solar-powered technologies for soaring competitions in the future is concerned. In 23 days, logging 125 flight hours, he covered the distance from California to North Carolina, leg by leg,

based on sun power only. Every time take-off was based on the stored energy captured in approximately 90 minutes by the flexible photovoltaic adhesive film on its wing and tail surfaces (References 14,15,16).

1996: The winner, and only flying airplane, of the Berblinger Prize 1996 (Reference 17), was the Icarè 2, built in the Institute of Aircraft Construction of the University of Stuttgart.

It represented an excellent integration of all the most advanced standard in all the relevant technical disciplines, thus demonstrating outstanding performance as well as a further confirmation of the actual feasibility of solar flight. Worth of mention is the fact the Icarè meets standard airworthiness requirements, is granted a provisional JAR 22 certificate of airworthiness and does not imply any restriction to the weight of the pilot, which was the case for some of its predecessors (Reference 18).

4. Discussion on classification

It has been clearly demonstrated by many authors (References 19,20,21,22) that today and probably for long time gliders will be the only heavier-than-air manned flying machine to take advantage of electrical and solar power because of the limited energy level involved. In fact, no matter how light or energy efficient a solar powered aircraft is, it will still be under powered. Airships and unmanned aircraft will probably more easily take advantage of these emerging technologies for propulsion. FAI shall therefore deal with unmanned aircraft and airships as well. However, remaining within the purpose of this paper, let us consider manned fixed wing machines only. As a first step let us then take into account the definition of "glider" (Reference 23).

"A fixed wing aerodyne having no means of propulsion."

According to this definition, therefore, the machines we are talking about should not be considered "gliders," may-be "motor-gliders?" Let us see that definition: a Motorglider is "A fixed wing aerodyne equipped with means of propulsion, capable of sustained soaring flights

with means of propulsion inoperative."

According to this definition an electrical-powered fixed wing flying machine, which took advantage of its propulsion system just for take-off and climb and sustaining soaring flight with such means inoperative, would still be considered a MOTORGLIDER. If the same machine, in addition, were capable of capturing sun energy during flight and store it, or using it during temporary powered flight phases, still would be a MOTORGLIDER.

Having said that, it could seem that there is no actual need to further introduce definitions for MOTORGLIDERS which use electrical energy stored in batteries, fuel cells or obtained from the sun radiation impacting on their surfaces. This might be true in principle, but it is obvious that the performance of a "conventional" motorglider are at present much different from those of an electrically powered or sun powered one.

For the time being, therefore, it would not make sense to have those different kinds of motorgliders competing together (this applies, in particular, to those sun-powered, the wing loading of which are necessarily very low).

For competition purposes, therefore, it could be sensible to define one (or more?) sub groups of MOTORGLIDERS, differentiating those which use reciprocating engines from those which use electrical ones.

Once accepted the presence of a "family" of electrical motor-gliders, the subsequent question would be: is it necessary to differentiate between those which take advantage of pre-stored energy only (e.g. batteries) and others than can capture sun radiation and use it immediately or after storing it into batteries. And what about the requirement of sustained flight based on sun-radiation only, as it was requested by the "Berblinger prize '96" (Reference 17). In order to better discuss this subject let us have a look at the technical requirements of that competition, the first in the world held so far for solar-powered aircraft:

- Weight of the pilot 90 Kg.
- Top speed not less than 120 Km/h
- Best efficiency not less than 20
- Minimum rate of descent not more than 1 m/s
- Stall speed less than 60 Km/h
- Climb rate after take-off, average 2 m/s for 225 sec. (if necessary by the use of stored energy)
- Sustained level flight with a sun radiation of 500 watt/m²

It can be demonstrated, for now, that this performance can be attained only by integrating the solar power by means of high quality batteries for take-off and climb. In particular the weight of the pilot and the climb rate requirement practically prevent a pure solar-powered motor-glider to comply.

Many of those presently engaged in studies and design of solar-powered aircraft have been contacted and involved in this discussion. There are different opinions, of course, and the survey undertaken by F.A.I. is still under way. Some of the comments received so far are

recurring and interesting to be presented as a reference for further consideration.

It is a common understanding that one of the leading parameters as far as the performance of a solar powered glider is the efficiency/quality of the solar cells. It is also a common, obvious understanding, that such technology is evolving very rapidly and their cost, although more affordable than in the past, is still very high. These two last reasons will still for some time strongly differentiate between groups of designers capable or not of affording the highest-performance solar cells and related equipment. On the other hand it would be very difficult to impose limits to the power system performance and, moreover, to properly measure it. The concept of "self-sustainability" with a defined sun radiation (e.g. 500 watt/m²) would be difficult to be verified. On the other hand, if a certain sun radiation intensity is considered today the boundary limit between "sun-powered self-sustained" aircraft and those which are just "sun-power assisted," it would move towards lower levels of sun radiation in the future.

In addition, from a pure world record stand point, is it really necessary to define a sun-radiation limit or a certain minimum climbing rate?

The merit of the Berblinger prize has been very important, having pushed in the direction of assessing the state of the art in all the different disciplines involved and demonstrating the feasibility of the concept, thus calling for the attention of media and of the worldwide public on these emerging technologies.

However it is quite a shared opinion that also other formulas could be profitably considered, capable of producing some acceleration in the availability of sport aircraft for actual competition within a few years.

As a further provocation, let us consider the approach followed by Eric Raymond with his interesting "Sunseeker," a light glider with an electrical power plant. It can not maintain level flight based on sun radiation alone. In fact the size of the surface covered by a flexible photovoltaic film and the limited efficiency of the film itself do not provide the necessary power level for sustained steady flight. Nevertheless the Sunseeker has demonstrated the possibility of crossing the U.S.A. from coast to coast, leg by leg, in 23 days, without being ever towed, using for take-off and climb only the electrical energy stored in its batteries during stops on ground and, partially, in flight.

This was happening in 1986, but today the technology of light flexible solar-film is in progress and much better performance would be attainable.

A significant asset of the Sunseeker is its capability to well integrate good soaring capability with that of accumulating reasonable amounts of solar energy in relatively short time. Projected into the near future, it could represent a good reference example for a possible class of competition machines.

In terms of competitions it is interesting mentioning

the "Airborne Solar Challenge," a new competition that will be held in 1998 in Australia for solar-powered aircraft. Australia hosts since years the World solar car challenge, which traverses the country from north to south along a route of more than 3000 km. For the first time, next year, the competition will be open to solar-powered aircraft. As competitors shall remain within the path allocated by the organizers, it is quite obvious that the requirement of sustained flight is a must, and performance similar to those foreseen by the Berblinger prize shall be demonstrated (see Icarè).

A similar kind of competition, though much less demanding, might be organized renouncing to the requirement of predefined flight path along tight corridors but, as for gliding competitions, defining turning points and/or arrival point for each leg (see Sunseeker).

It is clear that we are observing a movement that is just performing its first steps, but there are great potentialities in it and soon there will be the need for organizing competitions.

Keeping this in mind, without any ambition to anticipate any decision, but just with the aim of provoking discussions and thoughts on this subject, a preliminary attempt at grouping could be drafted:

ELECTRICAL-POWERED (Battery operated) AIRCRAFT/Motorgliders:

It is unlikely, for the time being, that electrical-powered "aircraft" can be produced, capable of remaining airborne for a significant time; however, for world record breaking, they can be taken into account.

On the contrary it has already been demonstrated by some examples (see also References 2,6,15,18), that an electrical-powered motorglider can take-off and climb at soaring height using battery-stored energy.

In some cases the stored energy was just sufficient for a take-off and climb, its wing loading not too low and the gliding performance comparable with those of a conventional one.

ELECTRICAL-POWERED (Other than battery operated) AIRCRAFT/Motorgliders:

Same as above, but adopting means of electrical energy accumulation different from batteries (e.g. fuel cells, flywheels). Such a category will develop in a few years.

SOLAR-POWERED AIRCRAFT

(At present, as pointed out above, a defined intensity of 500 watt/m² for level flight is mentioned by the present F.A.I. definition). It should be considered whether this definition is worth being differentiated. Leaving this definition as it is, would lead to a trend towards very extreme aircraft. The requirement of maintaining level flight makes the difference between aircraft and motorgliders; competitions, in this case, would be carried out mainly flying along well defined more or less straight line (see, for instance, the aforementioned "Airborne World Solar Challenge" (Reference 24)).

SOLAR-POWERED MOTORGLIDERS:

A less demanding group of vehicles would be that of

solar-powered motorgliders.

Keeping in mind the definition of motorglider (a fixed wing aerodyne equipped with means of propulsion capable of sustained soaring flight with means of propulsion inoperative), a solar-powered motorglider would be an electrical-powered motorglider (see above) with the additional peculiarity of collecting solar energy via solar panels, no matter at which sun radiation and no matter how much. Are there reasons for introducing further definitions as far as energy levels are concerned? Competition for this kind of vehicle should give priority to the soaring capability, taking advantage of solar power for direct engine powering or for charging batteries before (and during) take-off and climb; this is probably the main question to deal with in the immediate future, thinking of solar-powered motorgliders competitions.

It is in fact obvious, and both Solar Challenger and Icarè are good demonstrations, that the level of solar power obtained by a vehicle is somehow directly related to a degradation in its soaring effectiveness. In order to make the power available sufficient for level flight, in fact, one requires low wing loading, low airspeed, large wing/tail surfaces and optimized aerodynamics at high incidence. All this penalizes, to some extent, the "pure" soaring and penetration against head wind capabilities. On the other hand, if the solar power plays a more important role in the energy balance of a certain motor-glider, it can perform better in a situation where the convective activity is poor and the path to be followed more straightforward. The question is: shall we leave this compromise open to the designers or is it better to more rigidly define "frames," In this latter case, however, the difficulty of managing, during competitions, all the relevant measurements shall be considered.

Leaving to the designer the maximum freedom would lead to extreme machines, costly and sophisticated, which would be, in most cases, the result of a "research" activity. They would be the breakers of world records and the subject of challenging performance like Channel crossing, Alps crossing etc.

In order to make cheaper aircraft and competitions more affordable, balanced and attractive for pilots as well it would be preferable to refer to "limited" or "standardized" categories; limit the maximum efficiency of solar panels, for instance, would limit the cost, to limit the surface of solar panels would make the overall performance in poor meteorological conditions more balanced.

An approach similar to that adopted for gliding competitions might be perhaps a possible solution: a sort of "well defined" standard class" for rewarding pilots and a "open" class for awarding designers and promoting the technical developments without constraints.

Also the kind of competitions could be different from the typical motor-gliders competitions.

To this respect it will be interesting to monitor the experience acquired by the Solar Challenge 1998 in Australia.

5. Conclusions

Although the first air vehicle in the history was powered by an electrical power plant, the application of electrical power and solar energy for propulsion of aircraft has remained for many years just a curiosity.

In the last twenty years the development in the relevant technologies has progressed very rapidly. The performance of solar panels, as well as that of electrical batteries and electrical motors has improved quite significantly and their cost has become more affordable. A few interesting prototypes have been realized in the world, demonstrating the maturity of the relevant technologies for application to sport flying in the near future. The trend of development in the involved technical disciplines is nowadays so rapid that it is reasonable to predict the need, in the very near future, for precise new definitions and rules. They will have to consider electrically operated motorgliders (using batteries or other storage means) and solar-powered motorgliders (either supported or not by batteries or by other energy accumulation means).

Several questions shall have to be carefully addressed before formalizing new definitions. In fact, also due to the very high cost of some components (e.g. high efficiency solar panels and fuel cells), possible limitations and/or standardization in their performance could significantly affect the development of new categories of sport aircraft.

6. Acknowledgments

The author is indebted to Dr. Ing. Marco Cherubini for his collaboration in preparing this paper and, in particular, for all the free-hand drawings herein presented.

7. References

- 1) K.A. Berness et al: "High-Efficiency GaInP/GaAs Tandem Solar Cells" *Journal of Propulsion and Power* Vol. 12, No.5, Sept-Oct. 1996;
- 2) P. Duranti, S. Duranti: "Development and Flight-testing of an electrically-powered motor-glider"; 8th European Symposium of The Society of Flight Test Engineers; Blackpool (U.K) 1996.
- 3) H.W.Brandhorst et alii: "Technologies for Spacecraft Electric Power Systems"; "Journal of Propulsion and Power"; Vol. 12, No.5, Sept.-Oct. 1996.
- 4) P. Duranti, F. Quagliotti ML "Aeroplano a Propulsione Elettrica Solare"; Estratti da Giornata di studio in memoria del Prof. Attilio Lausetti; Politecnico di Torino, 7/5/1993;
- 5) R.J. Boucher: "Solar Powered Flight: History and Prospects"; Astro Flight Inc.
- 6) H.Brditschka: "Das Elektro-Motorflugzeug MB-E1 und seine Entstehungsgeschichte"; Brditschka OHG,1973.
- 7) R. J. Boucher: "Sunrise, the World's First Solar-Powered Airplane"; *Journal of Aircraft*, Vol. 22, No. 10, Oct. 1985.

- 8) *Aerokurier* 11/79: "Die Solar One: Europas erster Sonnen-Segler.
- 9) *Aircraft Engineering*: "First Solar-Powered Manned Flight," Oct. 1979.
- 10) P. B. MacCready, P.B.S. Lissaman, W.R. Morgan, J.D. Burke "Sun-Powered Aircraft Designs," "Journal of aircraft" Vol.20, No.6, June1983.
- 11) Martyn Cowley: "SolarChallenger"; "Aeromodeller", June 1981. 12) *Aerokurier* 6/82: "Sonnenzellenflugzeug Solair 1: Eindrucksvolle Demonstration nach der ILA."
- 13) S.F. Brown: "The Eternal Airplane"; "Popular Science," April 1994.
- 14) E. Raymond, K.Heinzmann, N. "Prototype of a Solar Assisted Electric Self-Launching Sailplane"; XXIII OSTIV Congress 1993, (Sweden).
- 15) M. Hackleman: "With sun on its Wings"; "Alternative Transportation News," May, 1991.
- 16) Y. Kishi et al: "Ultralight Flexible Amorphous Silicon Solar Cells and its Application for an Airplane"; Sanyo Electric Co., Ltd., Japan; 5th International Photovoltaic Science and Engineering Conference; 1990, Kyoto.
- 17) Berblinger Prize 1996 Announcement; Stadt Ulm, Kulturamt, Germany.
- 18) M. Rehmert, B. Kroeplin: "Human Flight with Light"; OSTIV Sailplane Development Panel, Helsinki,Finland,1996.
- 19) E. Schoeberl "Solar-Powered Aircraft Design"; XXI OSTIV Congress, Wiener-Neustadt, Austria (1989).
- 20) S.A. Brandt, F.T.Gilliam "Design Analysis Methodology for Solar-Powered Aircraft"; "Journal of Aircraft" Vol. 32, No.4, July-Aug. 1995.
- 21) J. Gedeon: "Some thoughts on the Feasibility of a Solar-powered Plane," Techn. University Budapest, 1979.
- 22) F.G. Irving and D. Morgan "The Feasibility of an Aircraft Propelled by Solar Energy"; Imperial College of Science and Technology, Dept. of Aeronautics, London.
- 23) F.A.I.(Federation Aeronautique International) Sporting code - Gen. section (1996 edition including amendment 1,1/1/97).
- 24) AIRBORNE World Solar Challenge Regulations (October 1996); AIRBORNE World Solar Challenge Foundation.
- 25) A.J. Colozza: "Effect of Power System Technology and Mission Requirements on High altitude Long Endurance Aircraft," NASA CR 194455.
- 26) G.A. Landis et alii: "Recent Advances in Solar Cells Technology"; "Journal of Propulsion and Power"; Vol.12, No. 5, Sept.-Oct. 1996.