

NUMERICAL PREDICTIONS OF GROUND EFFECT ON NACA 0012

by Mauro Darida and Ladislav Smrcek

Presented at the XXV OSTIV Congress, St. Auban, France

ABSTRACT

In this paper, the CFD package Rampant was used to predict the fluid flow around a NACA 0012 airfoil numerically at varying heights above the ground and at varying angles of attack. These results were then compared with experimental values of lift coefficient and pressure coefficient on the airfoil surface. Only positive angles of attack (with the exception of -4 degrees) were regarded of practical interest in flight and therefore simulated.

It has been found a good agreement with the experimental data until a value of 0.5 for the ground distance/airfoil chord ratio. The quality of the obtained prediction is lower for values below 0.5, but in most aeronautical applications we seldom have airfoil/ground distances below this value.

INTRODUCTION

Ground effect has been observed since the first decade of this century, but it is still challenging to gather information on specific cases. The aim of this study was to simulate the effects of the ground on an airfoil flying in close proximity to it, a situation which certainly occurs during the landing phase of sailplanes.

Ground effects are an increase in lift coefficient for a given drag coefficient compared to free stream values. In fact, downwash velocities are decreased when a wing is operating close to the ground, as it is a solid boundary to which the normal component of velocity must vanish. Three software packages were used:

- PreBFC - a CAD style geometry setup;
- TGrid - a mesh generation package;
- Rampant - a numerical solver.

All three packages were developed by Fluent Inc. and are therefore designed to interact with one another. The geometry and experimental values were taken from Reference 1.

PROBLEM DESCRIPTION

The study used a NACA 0012 airfoil with a chord length of 0.1 m. The airfoil was placed at several distances from the ground (Figure 1) as follows:

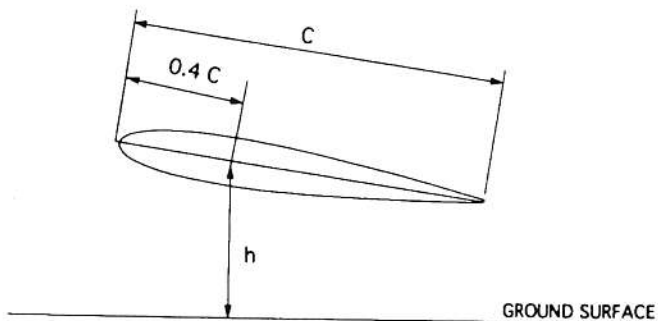
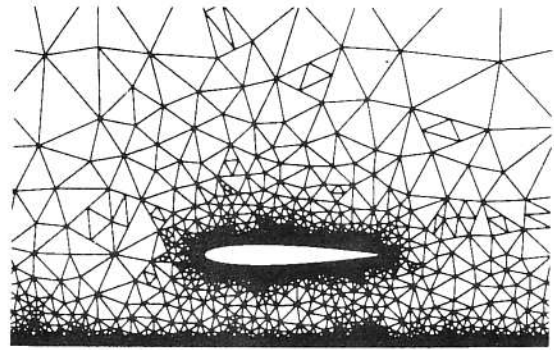

FIGURE 1.



h/c = 0.5
Unstructured Grid (5147 Nodes)
Alpha = 0 deg

Fluent Inc.
Rampant 4.0 (2d)
Tue Mar 25 1997

FIGURE 2.

h/c values 1, 0.75, 0.50, 0.35, 0.25, 0.15
and at varying angles of attack as follows:
angles of attack (deg) -4, 0, 3, 4, 5, 6, 8

Only one negative value was investigated as it is very unlikely that, in a real life situation, an airfoil would be flying at a negative angle of attack this close to the ground. Each configuration was calculated at a Reynolds number of 220000 and at a Mach number of 0.1, according to the experimental data (Reference 1).

The basic unstructured triangular mesh used for the computations is shown in Figure 2. In PreBFC 200 nodes were placed evenly about the airfoil, 300 along the surface simulating the ground and 25 along each of the boundary edges. The "smooth nodes" command was then used for the weighting of the density of the nodes. On the airfoil there was a weighting of 3.5 to 1 from the leading edge to the trailing edge. A weighting factor greater than one causes the nodes to be pulled towards an end, while a value less than one pushes them away. On the ground there was a weighting of 30 to 0.1 from the point directly below the airfoil to the outer edge of the area. The profile was rotated about the point at 40% of the chord line using the "rotation" command in order to set a certain given angle of attack prior to generating the mesh.

The boundary zone types (Figure 3) in Rampant were set as "wall" for the profile and the ground, while "pressure-far-field" was used to model the free stream flow at infinity.

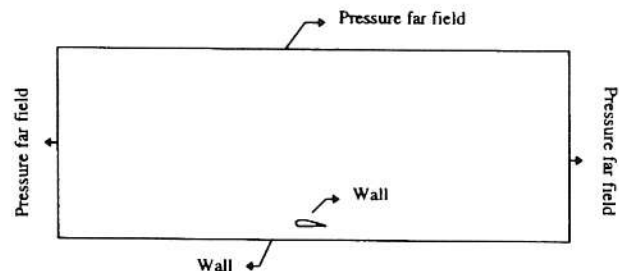

FIGURE 3.

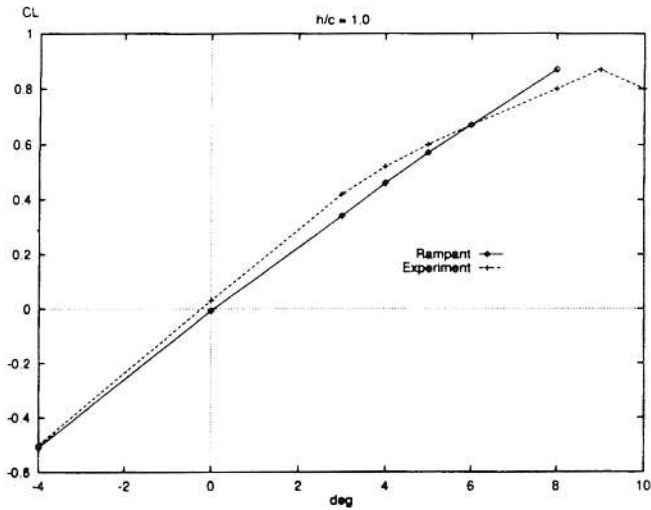

FIGURE 4.

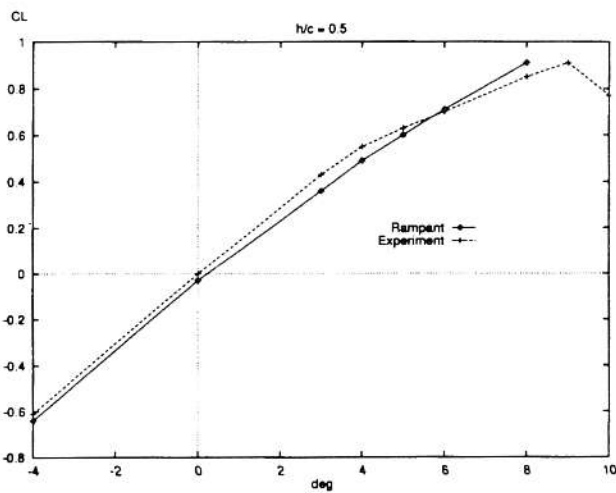

FIGURE 5.

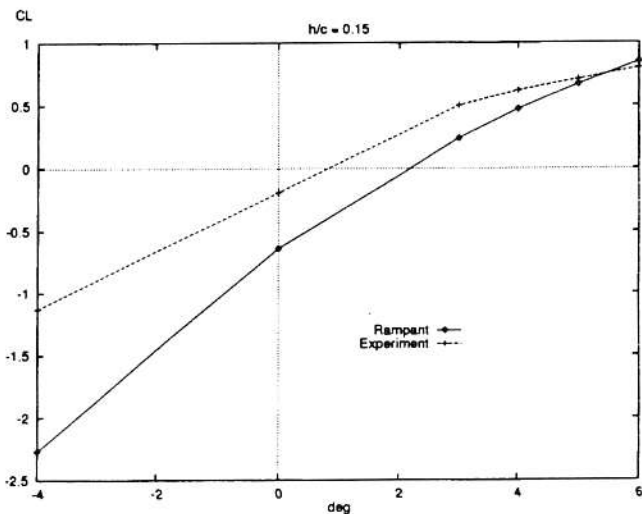

FIGURE 6.

PERFORMING COMPUTATIONS

The inviscid model was used, in which Rampant solves the Euler equations. Multigrid levels were initially set at the default values. Multigrid is a technique used to accelerate convergence by approximating the solution on successively coarser grid levels. Although the iteration takes longer, it enables the flow information to propagate more quickly with each iteration, thus saving in computational effort. The higher the multigrid levels are, the quicker convergence is reached, however the more unstable the solver. For small values of h/c at large angles of attack the multigrid levels had to be decreased. The solution was considered converged when the residual reduction was of the order of magnitude of 10^{-4} .

The turbulent model was experienced with, but results were not promising and convergence difficult to achieve: the multigrid levels had to be altered at critical stages in the calculations or unstable oscillations of the residuals occurred. Eventually efforts were devoted to the use of the

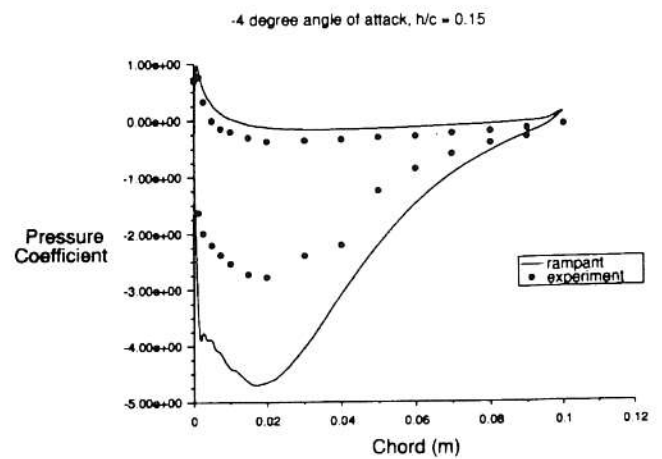

FIGURE 7.

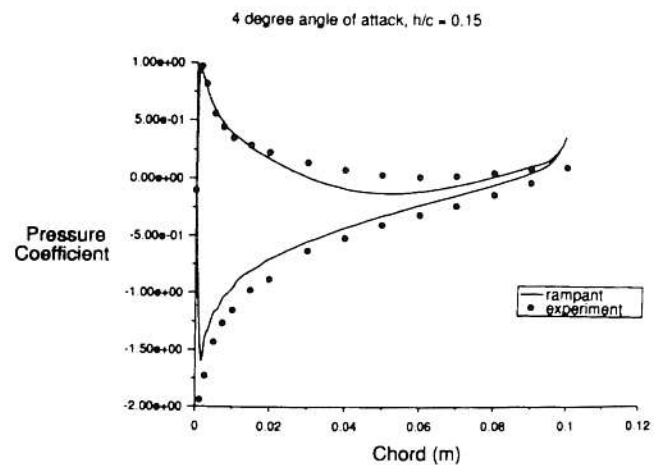

FIGURE 8.

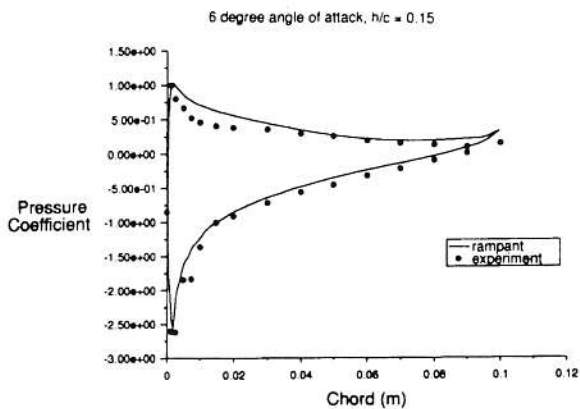

FIGURE 9.

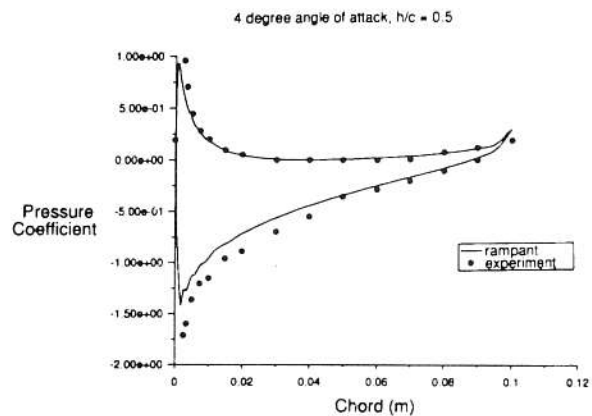

FIGURE 11.

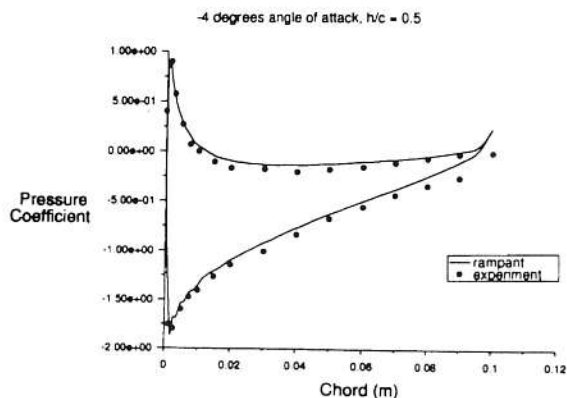

FIGURE 10.

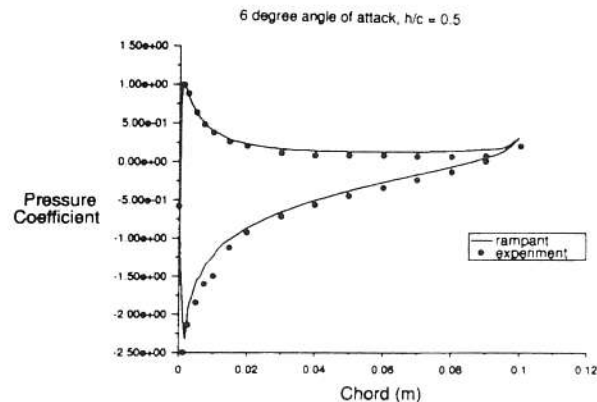

FIGURE 12.

inviscid model only.

RESULTS

The numerically predicted lift coefficients obtained using Rampant are compared with the experimental ones in Figures 4, 5, 6. For angles of attack less than 8 degrees the Rampant predictions compare favorably with the experimental data down to an h/c value of 0.5. For larger angles of attack, as the stall is approached, the Rampant inviscid model becomes inadequate. In addition, for h/c values less than 0.5 the Rampant predictions do not correspond well with the experimental ones, particularly at negative and zero angles of attack.

Figures from 7 to 12 show the comparison between the experimental results and the predicted pressure coefficients. Only a selection of angles of attack (-4, 4, 6 degrees) and heights is shown, however they show the trends that developed where viscous effects were assumed to be negligible. Agreement with experimental values got worse as h/c decreased but conversely got better as the angle of attack increased. The graphs also show that the pressure distribution on the lower surface of the airfoil was always more affected than the upper surface no matter what the angle of attack, which is a trend observed experimentally.

CONCLUSION

The CFD package Rampant was used to simulate ground

effect on a NACA 0012 profile at various angles of attack and distances from the ground. The results were compared with experimental data and showed that Rampant modeled the ground effect well down to an h/c value of 0.5. This was shown in both the pressure coefficient and the lift coefficient graphs.

As h/c decreases below a value of 0.5 the quality of the obtained prediction is lower and at zero and negative angles of attack the lift and pressure coefficients are extremely large. However, in most aeronautical applications we seldom have airfoil/ground distances below this value, consequently predictions like those presented in this paper may well be valuable in reference to the high aspect ratio wings employed on sailplanes.

ACKNOWLEDGEMENTS

The authors wish to thank the final year student Antonia Johnson for her contribution to this paper and the Aeronautical Research and Testing Institute in Prague, mainly Ing. Z. Patek, for granting permission to use their experimental data.

REFERENCES

1. Patek, Z., "Etude Experimentale et Teorique de l'Effet de Sol," SUPAERO, Toulouse, Rapport de Fin d'Etudes, 1992.