

# Flight Path Optimization for Competition Sailplanes through State Variables Parameterization

Paulo Iscold and Ricardo L. Utsch de F. Pinto  
*Center for Aeronautical Studies of the Federal University of Minas Gerais*  
*Belo Horizonte, Minas Gerais, 31270-901, Brasil*  
 iscold@ufmg.br, utsch@demec.ufmg.br

Accepted by the XXIX OSTIV Congress, Luesse-Berlin, Germany, 6 August – 13 August 2008

## Abstract

This paper presents a numerical process for determining optimal flight paths for competition soaring. The goal is reduction of flight time required to fly towards an ascending thermal and climb to a given altitude. The optimization procedure applies a direct method to obtain sub-optimal solutions through parameterization of state variables, unlike a previous study by the same authors which was based on control parameterization. A mathematical programming procedure is used to determine the sub-optimal values for the parameterized state variables. The optimal control law, which is necessary for the generation of the sub-optimal state, is obtained through a step-by-step penalty technique. The results demonstrate that the optimization of transitory phases is important for the minimization of total flight time.

## Introduction

The classic problem of cross-country sailplane flight trajectory (Fig. 1) consists in minimizing the time spent flying between two thermals (A-B) and climbing back to the starting altitude (B-C).<sup>1-3</sup> The classic solution for this problem, presented in the 1950's by MacCready,<sup>4</sup> is based on an equilibrium analysis which does not account for the transitory effects during the trajectory. Other authors<sup>5-12</sup> presented studies using dynamic models which account for the transitory effects of the problem, however, their models were simplified.

Recently, preliminary results were presented regarding optimization of a sailplane flight path, based on a dynamic model for symmetric flight, without analysis of climbing flight<sup>6</sup>. This paper, a continuation an earlier study<sup>13</sup>, shows the entire problem, taking into consideration: i) the acceleration phase as the sailplane leaves the thermal (pitch down); ii) the deceleration phase when the sailplane enters the thermal (pitch up) and iii) the phase of climbing within the thermal. Optimization is reached through parameterization of state, unlike the previous paper of the authors which was based on control parameterization.

## Problem definition

The complete problem to be analyzed in this paper can be seen in Fig. 2. According to this figure, the optimization process can be written as:

$$\min [t_{AB} + t_{BC} + t_{CD} + t_{DE}] \quad (1)$$

subject to:

$$\begin{aligned} V &\leq VNE; \\ n_z &\leq n_{z_{\max}} \\ \max_{0 < x < X_f} [z(0) - z(x)] &\leq h \\ \delta_{\min} &\leq \delta \leq \delta_{\max} \end{aligned} \quad (2)$$

The three first terms in Eq. (1) represent, respectively, time spent during the steps: acceleration, soaring, and deceleration. The fourth term represents the time spent in the climbing phase. The inequality constraints represent the upper operational limit of sailplane velocity (VNE), the load factor limit ( $n_{z_{\max}}$ ), the imposition that the initial altitude of the sailplane ( $h$ ) be greater than the largest altitude loss and the limits of elevator deflections ( $d_{\min}, d_{\max}$ ).

## Dynamical model

The dynamic model (Fig. 3) is the same as in Ref. 13, modified by the addition of simplified equations to represent the dynamic of the turning flight of the sailplane<sup>14</sup>.

As in Ref. 14, the state variables are:

$$\begin{aligned} x_1 &= x \\ x_2 &= z \\ x_3 &= \theta \\ x_4 &= \dot{x} = V_x \\ x_5 &= \dot{z} = V_z \\ x_6 &= \dot{\theta} = q \end{aligned} \quad (3)$$

The sailplane motion equations are:

$$\begin{aligned} \dot{x}_1 &= x_4 \\ \dot{x}_2 &= x_5 \\ \dot{x}_3 &= x_6 \\ \dot{x}_4 &= \frac{1}{m} [L \sin \eta - D \cos \eta + L_T \sin \gamma] \\ \dot{x}_5 &= \frac{1}{m} [-L \cos \eta \cos \phi - D \sin \eta \cos \phi + L_T \cos \gamma \cos \phi + W] \\ \dot{x}_6 &= \frac{1}{J} [M + L x_A \cos \alpha - L_T x_T \cos \alpha_T] \end{aligned} \quad (4)$$

where (see Fig. 3) the aerodynamics forces (lift and drag) and moments (pitch) can be calculated as:

$$L = \frac{1}{2} \rho(z) S C_L(\alpha) V_A^2 \quad (5)$$

$$D = \frac{1}{2} \rho(z) S C_D(\alpha) V_A^2 \quad (6)$$

$$M = \frac{1}{2} \rho(z) S \bar{c} C_M(\alpha) V_A^2 \quad (7)$$

where the relation between the airspeed ( $V_A$ ) and the inertial speeds ( $x_4, x_5$ ), including the effects of wind speed ( $u_x, u_z$ ) and wing bank angle ( $\phi$ ) is:

$$V_{Ax} = x_4 + u_x \quad (8)$$

$$V_{Az} = (x_5 + u_z) \cos \phi \quad (9)$$

$$V_A = \sqrt{V_{Ax}^2 + V_{Az}^2} \quad (10)$$

The sailplane path angle can be determined as:

$$\sin \eta = \frac{V_{Az}}{V_A} \quad (11)$$

$$\cos \eta = \frac{V_{Ax}}{V_A} \quad (12)$$

The lift force at the horizontal tail can be calculated as:

$$L_T = \frac{1}{2} \rho(z) S_T C_{LT}(\alpha_T; \delta) V_{AT}^2$$

where the airspeed at the tail, including the effects of downwash ( $w$ ) pitch ( $p$ ) and yaw speeds ( $q$ ), can be calculated as (see Fig. 3):

$$V_{AT} = \sqrt{V_{Ax}^2 + V_{Az}^2 + [2V_{Ax} \sin x_3 + 2V_{Az} \sin x_3 + \zeta] \cdot \zeta} \quad (13)$$

where:

$$\zeta = p + q - w \quad (14)$$

$$w \cong \alpha \frac{d\varepsilon}{d\alpha} V_A \quad (15)$$

$$p = x_6 \cdot x_T \quad (16)$$

$$q = \Omega \sin \phi \cdot x_T \quad (17)$$

$$\Omega = \frac{g \tan \phi}{\sqrt{V_x^2 + V_z^2}} \quad (18)$$

The airspeed angle and the attack angle at the horizontal tail can be calculated as:

$$\gamma = \alpha_T - x_3 \quad (19)$$

$$\alpha_T = \text{atg} \left( \frac{V_{NT}}{V_{TT}} \right) \quad (20)$$

$$\sin \alpha_T = \frac{V_{NT}}{V_{AT}} \quad (21)$$

$$\cos \alpha_T = \frac{V_{TT}}{V_{AT}} \quad (22)$$

These values permit the determination of tangent ( $V_{TT}$ ) and normal ( $V_{NT}$ ) airspeed at horizontal tail as:

$$V_{TT} = V_{Ax} \cos x_3 - V_{Az} \sin x_3 \quad (23)$$

$$V_{NT} = V_{Ax} \sin x_3 + V_{Az} \cos x_3 + p - w \quad (24)$$

In order to evaluate the constraints present in Eq. (2), it is necessary to state the following relation between the states variables and the load factor:

$$n_z = \dot{x}_5 \cos x_3 + \dot{x}_4 \sin x_3 \quad (25)$$

Notice that the previous equations included simplified equations for circular movement with small angular acceleration, which allows the analysis of climbs in thermals.

### Optimal control problem solution

In order to solve the optimization problem, it is assumed that the flight path is composed of the following phases (Fig. 4a):

- i) Starting from the climb flight velocity in the thermal ( $V_C$ ), the sailplane must accelerate to reach the velocity ( $V$ ). This flight phase involves a pitch down acceleration of the aircraft;
- ii) Once the velocity ( $V$ ) is reached, the sailplane must cruise with constant velocity;
- iii) Once cruising is completed, the sailplane must decelerate (pitch up) until it reaches, once again, the climb flight velocity within the thermal ( $V_C$ ).
- iv) Until the entire loss of altitude during the trajectory is regained, the sailplane must maintain climbing flight within the thermal with a constant velocity ( $V_C$ ).

For parameterization, it is assumed that the velocity evolution during the acceleration ( $\overline{AB}$ ) and deceleration ( $\overline{CD}$ ) will occur according to cubic polynomials. The cubic interpolations are performed by cubic Hermite polynomials. Then, the coefficients to be determined represent the velocity and the respective derivative values at the beginning and end of each phase (Fig. 5).

As suggested in Ref. 15, an approximation was used of the third degree using Hermite polynomials as:

$$z(\xi) = N_1(\xi) \alpha_0 + N_2(\xi) \alpha_1 + N_3(\xi) \beta_0 + N_4(\xi) \beta_1 \quad (26)$$

where:

$$N_1(\xi) = 2\xi^3 - 3\xi^2 + 1 \quad (27)$$

$$N_2(\xi) = -2\xi^3 + 3\xi^2 \quad (28)$$

$$N_3(\xi) = \xi^3 - 2\xi^2 + \xi \quad (29)$$

$$N_4(\xi) = \xi^3 - \xi^2 \quad (30)$$

where:

$$\xi = \frac{x - x_0}{x_1 - x_0} \quad (31)$$

$$\alpha_0 = y_0 \quad (32)$$

$$\alpha_1 = y_1 \quad (33)$$

$$\beta_0 = \left. \frac{dy}{dx} \right|_{x_0} \quad (34)$$

$$\beta_1 = \left. \frac{dy}{dx} \right|_{x_1} \quad (35)$$

As mentioned earlier, the dynamic model adopted accounts for, in a simplified manner, the sailplane in curved flight, which depends of the bank angle ( $\phi$ ). Therefore, it is necessary to determine a variation law for bank angle during the acceleration and deceleration phases.

In the present paper, a linear evolution of the bank angle is adopted, as shown in Fig. 4b. This profile introduces rolling velocities which are compatible with maneuver capabilities of typical sailplanes.

### Elevator deflection law

The elevator deflection law must be obtained along the numerical integration, step by step, as the one that minimizes the difference between the sailplane's flight velocity and a pre-established velocity.

Also, it is important to "teach" the numerical integrator the direction of the velocity variables. This is possible by adding to the objective function a term that corresponds to the condition of tangency to the flight trajectory.

Therefore, for each integration step, it is necessary to find the elevator angle ( $\delta$ ) which minimizes the function:

$$J(\delta) = k_1 [V(\delta) - \bar{V}]^2 + k_2 [V'(\delta) - \bar{V}']^2 \quad (36)$$

where  $V$  and  $V'$  denote, respectively, the sailplane flight velocity and its derivative with respect to the state variable  $x_1$ , while  $\bar{V}$  and  $\bar{V}'$  denote the respective pre-determined values. The constants  $k_1$  and  $k_2$  represent weights which must be chosen appropriately. For this paper, the following was successfully adopted:

$$k_1 = k_2 = 1 \quad (37)$$

Notice that optimal elevator angle ( $\delta$ ) can be found through a unidirectional search method. A procedure based on the Golden Section Method was chosen<sup>16</sup>.

### Optimization of flight trajectory

When the velocity profile shown in Fig. 4 is adopted, one will have, initially, the following parameters to be optimized:

- i) The flight velocity during the climbing ( $V_C$ );
- ii) Soaring velocity ( $V$ );
- iii) Acceleration distance ( $X_0$ );
- iv) Deceleration distance ( $X_1$ );

- v) The velocity derivatives in the cubic extremes ( $\bar{V}_0, \bar{V}_1, \bar{V}_2, \bar{V}_3$ ).

However, in order to smooth the velocity profiles, it was imposed that  $\bar{V}_0 = \bar{V}_1 = \bar{V}_2 = \bar{V}_3 = 0$ . In addition, the optimal flight velocity during climb flight ( $V_C$ ) was determined separately through a statistical analysis of the thermal rising flight problem.<sup>14</sup> Therefore, during the optimization procedure, this velocity is determined a priori. The three remaining optimization variables ( $V$ ,  $X_0$  and  $X_1$ ) were determined through a mathematical programming algorithm (Fletcher-Reeves Method) implemented by the authors.

This problem has been shown to be stable and easier than it seems, once, as shown through experiments, optimal  $V$ ,  $X_0$  and  $X_1$  were determined almost independently.

### Results

This procedure was applied for the optimization of the trajectory of a PIK-20-B sailplane with a wing load of 31.2kgf/m<sup>2</sup>,<sup>17-18</sup> with the distance between thermals ( $X_f$ ) ranging from 2000m to 16000m and thermal intensities ( $IT$ ) of 2m/s and 5m/s. The thermal profile adopted was:

$$V_{thermal} = \frac{IT}{2} \left[ 1 + \cos\left(\frac{\pi r}{R}\right) \right] \quad (17)$$

where  $R$  denotes the radius of the thermal ( $R = 250m$  was adopted).

Tables 1 and 2 present the optimal results obtained for the thermal intensities of 2m/s and 5m/s, respectively.

Figure 6 shows a typical trajectory (distance between thermals of 2000m and thermal intensity of 5m/s) obtained through the optimization procedure, where one can observe the optimal trajectory and the respective curves of: flight velocity, elevator deflection, load factor and mechanical energy (potential and kinetic) of the aircraft.

Notice in Tables 1 and 2 that the optimal distances of acceleration and deceleration are not sensitive to the variation in distance between thermals. Also, the optimal deceleration distance, in particular, does not vary in relation to thermal intensity. This translates into the fact that, in practical terms, the acceleration and deceleration can be optimized separately.

### Discussion

From Tables 3 and 4, it is clear that the relative gains obtained with the proposed optimization procedure are greater for smaller distances between thermals. Indeed, the greater the distance between thermals, the smaller the relative participation of the transitory phases (acceleration and deceleration). However, it is relevant to take into account the time gain accumulation during long competitions where, even small time gains on each thermal cycle can produce significant time saved at the end of the entire competition.

It is interesting to observe in Fig. 6 that, for an optimal acceleration, the sailplane must gain some altitude in the beginning of the glide, reducing total altitude gain during the accel-

eration phase. Also in the figure, it is seen that the load factor values associated to acceleration and deceleration maneuvers are within the sailplane operation limits, but are atypical if compared with usual values observed in such maneuvers.

Figure 7 shows a comparison between the optimal velocities obtained: i) through the proposed procedure and ii) through the two different interpretations of the MacCready theory. The different interpretations of the MacCready theory refer to the determination of the average velocity of climb flight. In the traditional interpretation of the MacCready theory, average climb velocity in thermals is the ratio between lost altitude until the beginning of the deceleration phase and time spent between this point and the end of the climb. The second interpretation considers as average velocity the climb velocity inside the thermal ( $V_{thermal}$ ).

One can observe that the difference between the soaring velocities obtained numerically and those obtained with the MacCready theories are greater the smaller the distance between thermals or the greater the intensity of the thermal.

Figure 8 shows a comparison between flight times using the three velocities presented in Fig. 7, with  $X_0$  and  $X_1$  optimized. Notice that, although the velocity differences are significant, flight time differences are imperceptible. This suggests that the time saved for flight, as observed in Tables 3 and 4 are owed almost exclusively to optimization of the acceleration and deceleration phases.

Finally, Fig. 9 presents a comparison between time loss due to flights in non-optimal airspeeds as calculated with the present procedure and as presented in Ref. 19. The optimal airspeed value, as calculated by the proposed procedure or by the MacCready theory, is the airspeed that results in no time loss. It must be noted that the time loss calculated with the present procedure (i.e. including the acceleration and deceleration phases) is lower than Ref. 18 indicates when the airspeed is lower than the optimal value. Furthermore, it is higher than Ref. 19 indicates when the airspeed is higher than the optimal value. This suggests that the penalty for flying with airspeeds below the optimal value is lower than the penalty predicted by Ref. 19, indicating that the recommendation of Ref. 19 to fly slower than the optimal airspeed is even better than what was expected.

### Conclusion

The optimization of competition sailplane flight trajectory was presented, including the acceleration and deceleration phases. A dynamical model was used using the elevator deflection as control variable. This model showed advantages over previous approaches as it makes possible detailed study of the transitions between the cruise and thermal phases of the flight, especially in order to verify constraints of load factor and elevator deflections. The obtained results, based on state parameterization, were compared to those of the MacCready theory and the usual acceleration and deceleration maneuvers. The advantages of the numerical procedure were significant, indicating that the practical considerations it takes into account are important.

Comparative results indicate that the optimal time is not sensitive to small variations in soaring velocity. This suggests that the indications proposed by the MacCready theory can continue to be used with little significant compromise to flight time. However, attention should be given to optimization of the phases of acceleration and deceleration.

One important result obtained is the time loss due to non-optimal airspeed flight. As suggested in many references, the time increased due to flying slower than the MacCready speed is not large, when you take into consideration that it allows for more time for decision making during the flight. The results obtained with the model proposed in this paper show that flying below the optimal speed, which is, in fact, slightly lower than the MacCready speed, especially in small thermal distances, is even less harmful than what had been expected when using the classic MacCready model.

### References

- <sup>1</sup>Weinholtz, F.W., "Teoria Básica do Moderno Vôo de Distância em Planadores", *Brazilian Soaring Association*, São Paulo, Brasil, 1967, 96p.
- <sup>2</sup>Reichman, H. "Cross-Country Soaring (Streckensegelflug)", *Thomson Publications*, Santa Monica, California, 1978, 151p.
- <sup>3</sup>Reichmann, H., "Flying Sailplanes – A practical training manual", *Motorbuch Verlag*, Stuttgart, 1980, 129p.
- <sup>4</sup>MacCready, P. B., "Optimum airspeed Selector", *Soaring*, Soaring Society of America, Vol. 18, No. 2, 1954.
- <sup>5</sup>De Jong, J. L., "The Convex Combination Approach", *XVII OSTIV Congress*, Paderborn, Germany, 1981, pp. 182-201.
- <sup>6</sup>Pierson, B., De Jong, J. L., "Cross-Country Sailplane Flight as a Dynamic Optimization Problem", *International Journal for Numerical Methods in Engineering*, Vol. 12, 1978, pp.1743-1759.
- <sup>7</sup>Vanderbei, R. J., "Case Studies in Trajectory Optimization: Trains, Planes and Others Pastimes", *Princeton University*, 2000, 29p.
- <sup>8</sup>Kawabe, H., Goto, N., "Sailplane Trajectory Optimization", *Technology Reports of Kyushu University*, Japan, Vol. 67, No. 5, 1994, pp. 609-616.
- <sup>9</sup>Kawabe, H., Goto, N., "Modified Direct Optimization Method for Optimal Control Problems", *Proceedings of the 48<sup>th</sup> Japan National Congress on Theoretical and Applied Mechanics*, Japan, 1999, pp.225-234.
- <sup>10</sup>Dickmanns, E. D., "Optimal Dolphin Style Soaring", *XVII OSTIV Congress*, Paderborn, Germany, 1981, pp. 210-212.
- <sup>11</sup>Metzger, D. E., Hedrick, J. K., "Optimal Flight Paths for Soaring Flight", *2<sup>nd</sup> International Symposium on the Technology and Science of Low Speed and Motorless*, AIAA-1974-1001, 1974, pp. 1-7.
- <sup>12</sup>Pierson, B. L., "A Discrete-Variable Approximation to Optimal Flight Paths", *Astronautica Acta*, Vol. 14, 1969, pp. 157-169.
- <sup>13</sup>Iscold, P., Pinto, R., "Mathematical modeling for Optimization of Competition Sailplane Flight: A Preliminary Approach", *XI Congresso Internacional da Engenharia da Mobilidade*, SAE Brasil, São Paulo, Brasil, 2003, 9p.
- <sup>14</sup>Thomas, F., "Fundamentals of Sailplane Design", *College Park Press*, College Park Maryland, 1999, 274p.
- <sup>15</sup>Pinto, R., "Estudo da Solução de Problemas de Controle Ótimo na forma de Bolza pelo Método dos Elementos Finitos", *Master Thesis*, Instituto Tecnológico de Aeronáutica, São José dos Campos, São Paulo, Brasil, 1982, 132p.

- <sup>16</sup>Luenberger, D. G., "Linear and Nonlinear Programming", Addison-Wesley Publishing Company, London, 1984.
- <sup>17</sup>Johnson, R. H., "A Further PIK-20B Flight Test Evaluation - Part II", *Soaring*, Soaring Society of America, Los Angeles, Vol. 42, No. 8, 1978.
- <sup>18</sup>Pinto, R., Barros, C. P., Iscold, P., "Um Procedimento Alternativo para Cálculo Aerodinâmico de Aeronaves Leves Subsônicas", *VII Congresso Internacional da Engenharia da Mobilidade*, SAE Brasil, São Paulo, Brasil, 1999, 10p.
- <sup>19</sup>Schuemann, W., "The Price You Pay for MacCready Speeds", *Soaring Symposia*, 1972, URL: [www.betsybyars.com/guy/soaring\\_symposia/72price.html](http://www.betsybyars.com/guy/soaring_symposia/72price.html)

**Table 1**  
Optimal results for Thermal Velocity  $IT = 2\text{m/s}$

$X_f$	$X_0[\text{m}]$	$X_I[\text{m}]$	$V[\text{m/s}]$	$t[\text{s}]$
<b>2000</b>	100	300	30.12	171
<b>4000</b>	100	300	30.54	317
<b>8000</b>	100	300	30.62	610
<b>16000</b>	100	300	30.55	1194

**Table 2**  
Optimal results for Thermal Velocity  $IT = 5\text{m/s}$

$X_f$	$X_0[\text{m}]$	$X_I[\text{m}]$	$V[\text{m/s}]$	$t[\text{s}]$
<b>2000</b>	125	300	38.86	93
<b>4000</b>	125	300	39.84	171
<b>8000</b>	125	300	40.08	327
<b>16000</b>	125	300	40.18	638

**Table 3**  
Comparison between optimal and usual times for Thermal Velocity  $IT = 2\text{m/s}$

$X_f$	$t_{opt}[\text{s}]$	$t_{MC}[\text{s}]$	$\Delta[\text{s}]$	$\Delta[\%]$
<b>2000</b>	164	171	-7	-4.2
<b>4000</b>	303	317	-15	-4.9
<b>8000</b>	596	610	-13	-2.2
<b>16000</b>	1184	1194	-10	-0.8

**Table 4**  
Comparison between optimal and usual times for Thermal Velocity  $IT = 5\text{m/s}$

$X_f$	$t_{opt}[\text{s}]$	$t_{MC}[\text{s}]$	$\Delta[\text{s}]$	$\Delta[\%]$
<b>2000</b>	90	93	-4	-4.0
<b>4000</b>	165	171	-7	-4.1
<b>8000</b>	320	327	-6	-2.0
<b>16000</b>	632	638	-6	-0.9

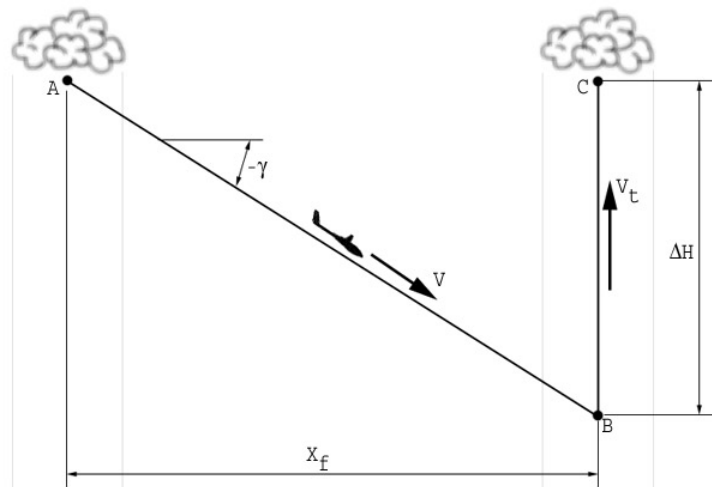

**Figure 1** Classic sailplane trajectory optimization problem

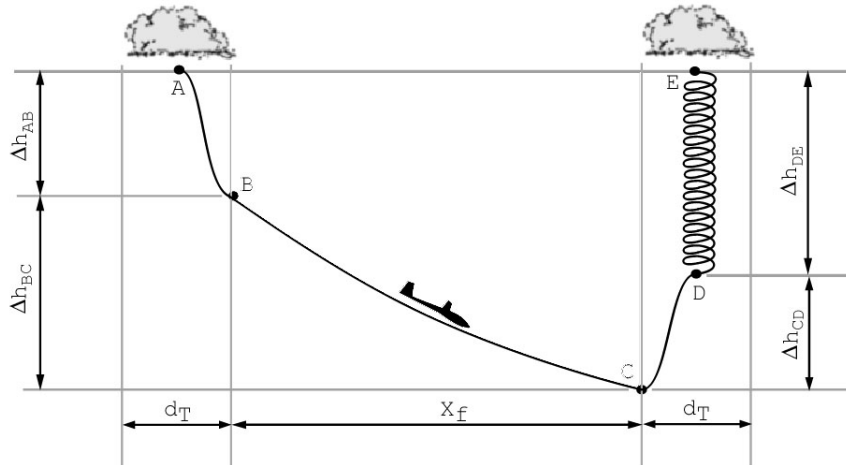

**Figure 2** Sailplane trajectory optimization problem with transitory and climbing phases

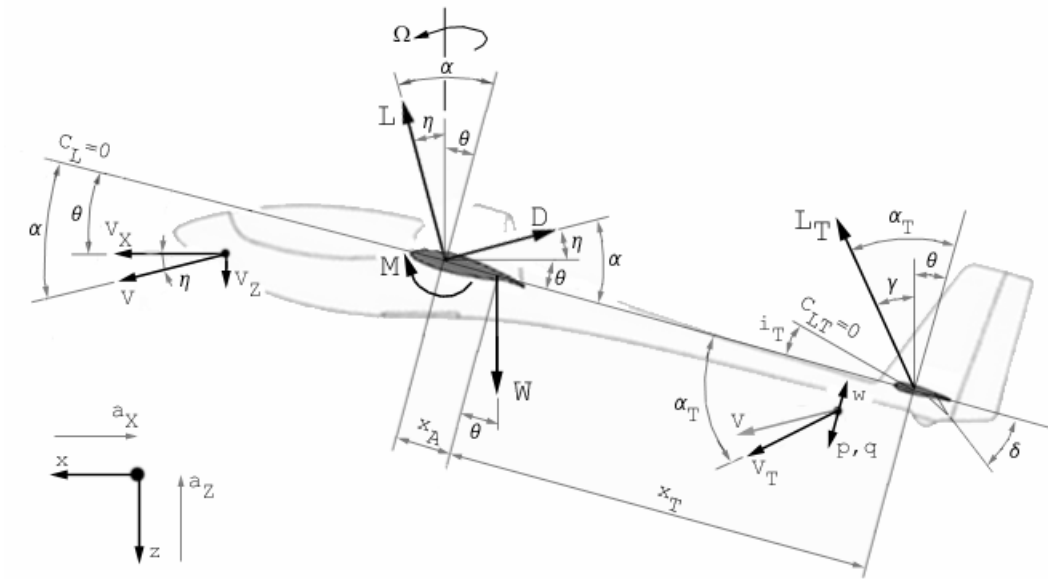

**Figure 3** Dynamic model

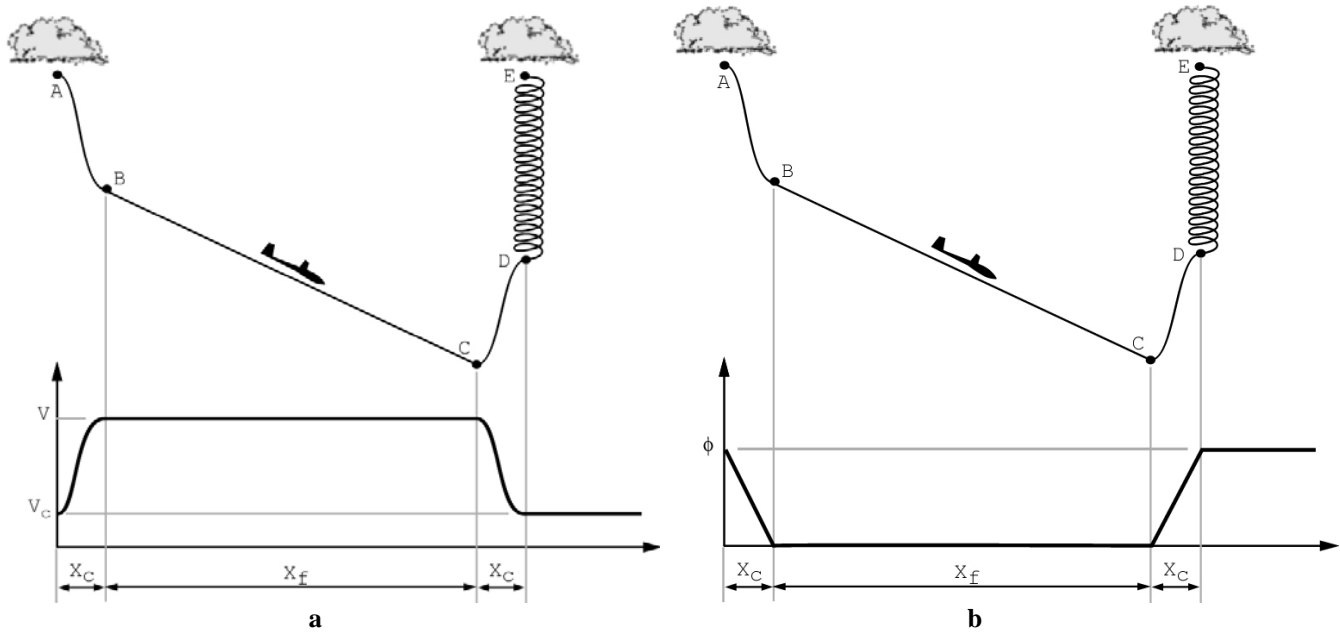

**Figure 4** a Typical airspeed and b bank angle profile during the proposed optimization procedure

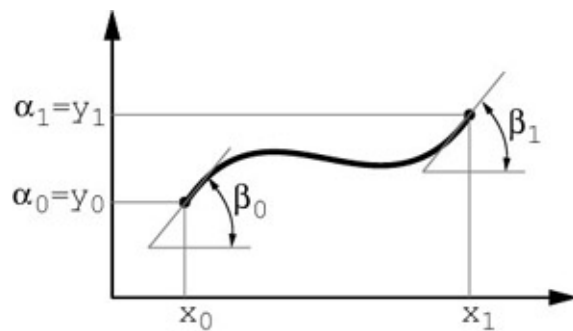

**Figure 5** Hermite polynomial parameters

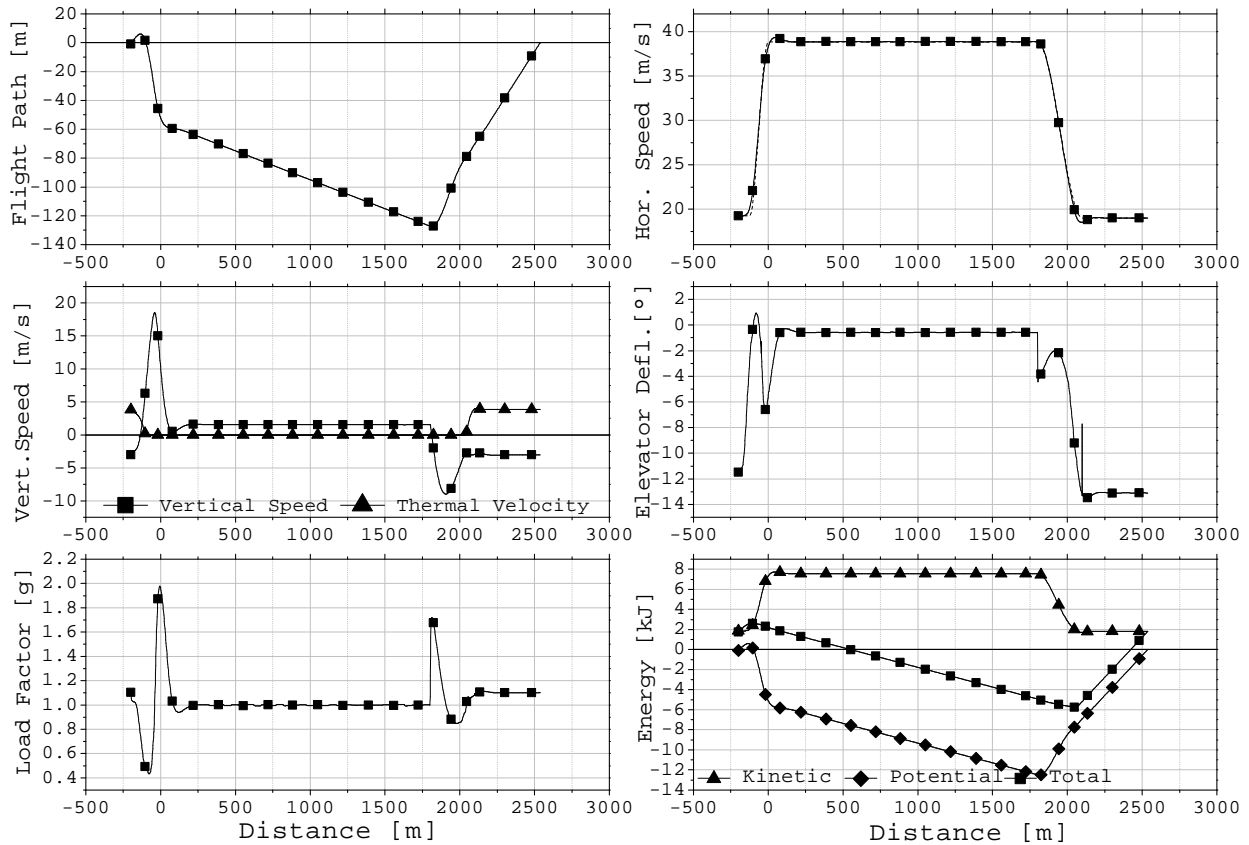

Figure 6 Typical optimal trajectory – Thermal Distance  $X_f = 2000\text{m}$  and Thermal Velocity  $IT = 5\text{m/s}$

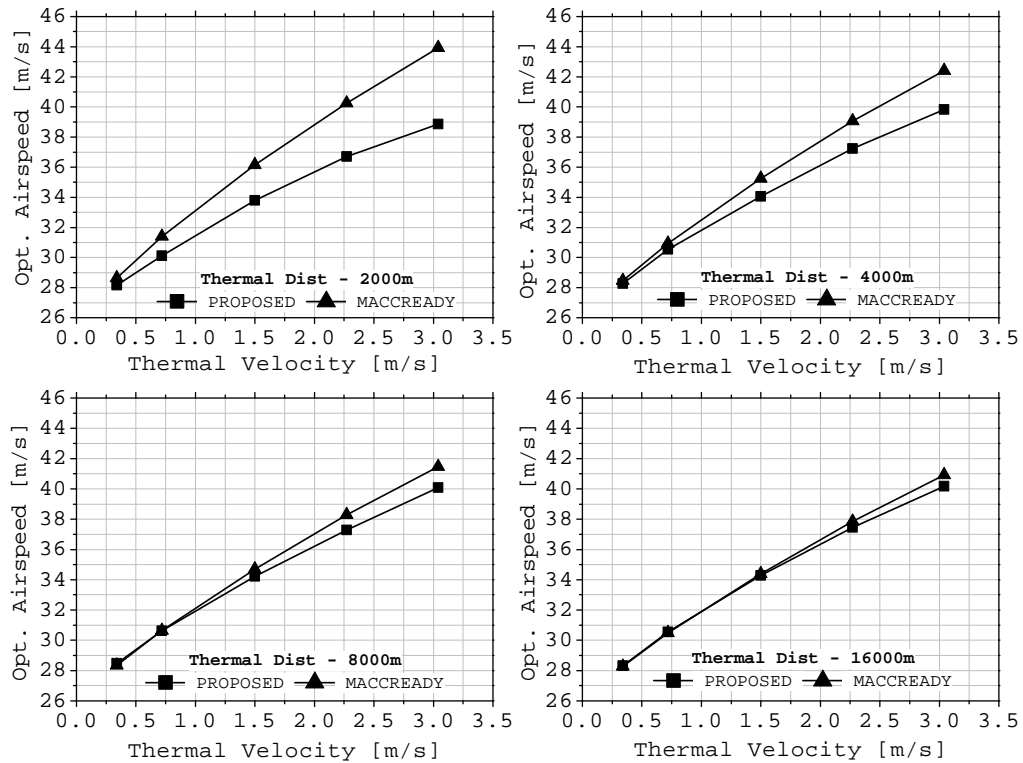

Figure 7 Comparison between optimal soaring airspeeds obtained by MacCready theory and proposed theory



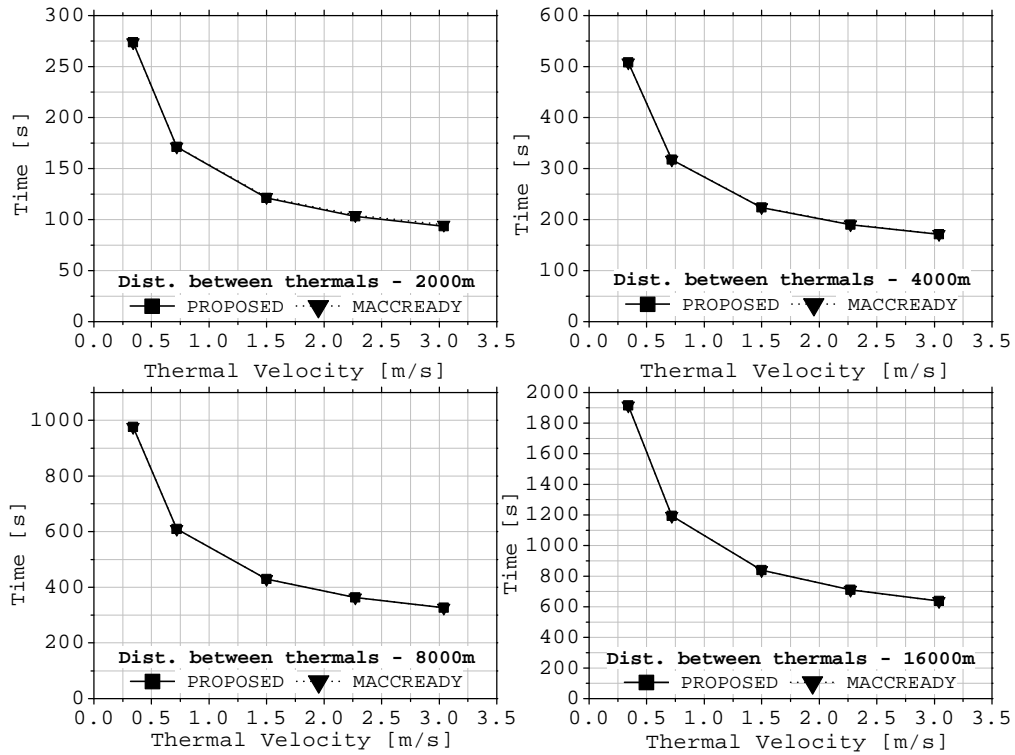

Figure 8 Comparison between optimal flight times obtained using MacCready theory and the proposed theory

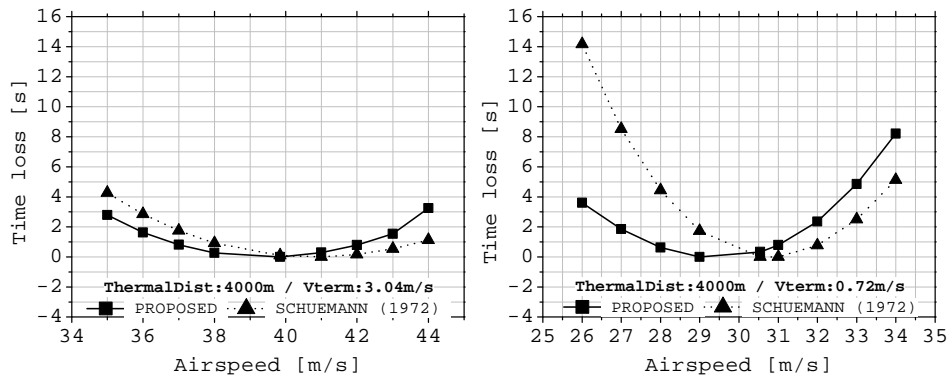

Figure 9 Comparison between time loss due to fly without the optimal airspeed obtained using MacCready theory (Ref. 18) and the proposed theory